



Cosmic Rays

Advanced FLUKA Course

Galactic Cosmic Rays

Composition:

90% protons, 9% Helium,
< 1% Ions (*particles*)
64% protons, 25% Helium,
11% Ions (*nucleons*)

Spectrum:

broad spectrum, peaks around
1 GeV/n

Intensity:

($E > 10$ MeV/n) ~ 5 p/(cm² s)
@ Solar Min.

Dose/Dose Equivalent:

~ 0.4 mGy/d, 1 mSv/d (no
geomagnetic cut off)

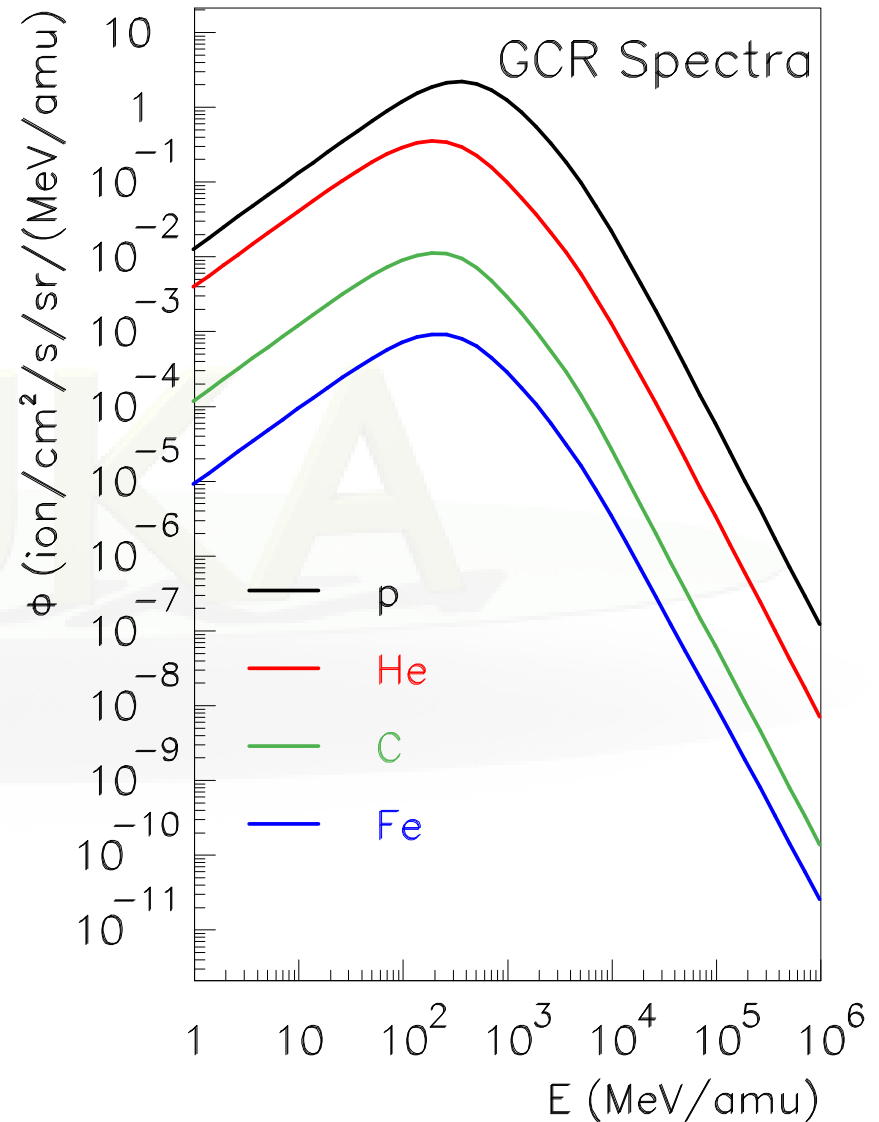

GCR: How To Calculate?

A full (and accurate) calculation requires:

- the determination of the **spectrum** and **composition** of cosmic rays at the **local interstellar medium**
- the determination of changing conditions in the **solar wind magnetic field** and the resulting **interaction** with the **inward flow of galactic cosmic rays** from the local interstellar medium
- the determination of the **trajectories** of cosmic rays through the Earth's **geomagnetic field**
- the **transport of the surviving incident cosmic rays** through the **Earth's atmosphere** to various depths.

GCR in FLUKA

- Primary **cosmic ray spectra** and interplanetary modulation according to measured **solar activity** on a day-to-day basis are available
- **Geomagnetic effects** are implemented with full multipole expansion
- **Extensive benchmarks** against available muon and hadron measurement data
- Used by **several laboratories** (Frascati, Siegen, Bartol, Houston, GSF,...) for simulating the radiation fields generated by **cosmic rays in the atmosphere and/or inside spacecrafts**

GCR: How To Calculate with FLUKA

The Galactic Cosmic Ray (GCR) component of the cosmic ray flux can be simulated up to 30 TeV/nucleon (or 500 TeV/n when DPMJET is linked)

The following **general options** are available concerning the simulation of cosmic ray interactions in FLUKA:

- **Superposition model:** in this approach (All-Nucleon Spectrum) primary **nuclei are split into equivalent independent nucleons**. See card PHYSICS with SDUM = IONSPLITti
- **DPMJET interaction model** (All-Particle Spectrum): this model **simulates the nucleus-nucleus collision above 5 GeV/nucleon**. In case DPMJET is chosen for cosmic ray application, for very high energies ($\sim 10^{16}$ eV) it is recommended to use the **DPMJET-II.5** version instead DPMJET-III.
(linking with the script `$FLUPRO/flutil/ldpm2qmd`)

The DPMJET and the superposition model can also be used together, by setting the respective energy ranges with the **PHYSICS** card.

The All-Particle spectrum

- The ion composition of the galactic flux is derived from a code (Badhwar & O'Neil 1996) which considers all elemental groups from $Z = 1$ to $Z = 28$ (Ni). The spectrum is modified to follow recent data sets from the AMS and BESS experiments up to 100 GeV, according to the so-called **ICRC2001** fit.
- The spectrum components are written in 28 files:

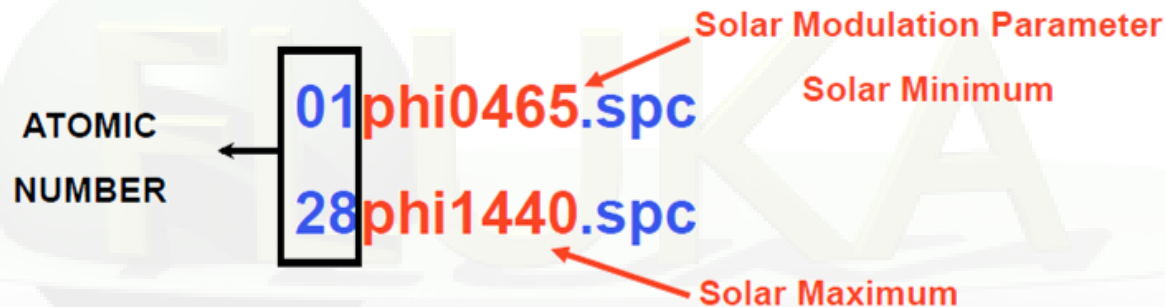

- These spectra are without geomagnetic cutoff. They are used together with an analytical calculation of the rigidity cutoff, according to a centered dipole approximation of the Earth geomagnetic field, adapted to result in the vertical cutoff inserted into the FLUKA input file (**SPECSOUR** command, SDUM = **GCR-IONF**, **WHAT(2)** of the continuation card), at the geomagnetic latitude and longitude of interest.

Spectra of Solar Particle Events of Jan 20th, 2005 and Oct 28th 2003 are also available

The ALL-Nucleon Spectrum (1)

- Based on a modified fit of the **All-Nucleon flux proposed by the Bartol group**, using the All-Particle Spectrum up to 100 GeV and data published in ICRC 2003
- For the **proton component at energies larger than 100 GeV**, using the normalization obtained at 100 GeV, a spectral index $\gamma = -2.71$ is assumed
- A spectral index $\gamma = -3.11$ is assumed **above the knee at 3000 TeV**
- For what concerns the **He component**, $\gamma = -2.59$ is used **above 100 GeV** and a charge-dependent knee is assumed according to the rule: $E_{\text{nucleon}} = Z * 3000 \text{ TeV}/A$
- Higher Z components have been grouped in **CNO, MgSi and Fe** sets and treated using an All-Particle spectrum with the above mentioned charge-dependent knee parameterization

The ALL-Nucleon Spectrum (2)

- Fluxes are read from a file named "**allnucok.dat**" giving the **total energy (GeV)**, the **fluxes (E.dN/dE)** and the **neutron/proton ratios**
- This option ("All Nucleon Flux") is chosen with command **SPECSOUR** and **SDUM = GCR-ALLF**
- The user can decide whether
 - ❑ to **sample neutrons and protons** from the file and to transport them **using the superposition model**
 - or
 - ❑ to consider all **neutrons as being bound in alpha particles** and to **transport protons and alphas (better for magnetic field effects)**

Solar modulation (1)

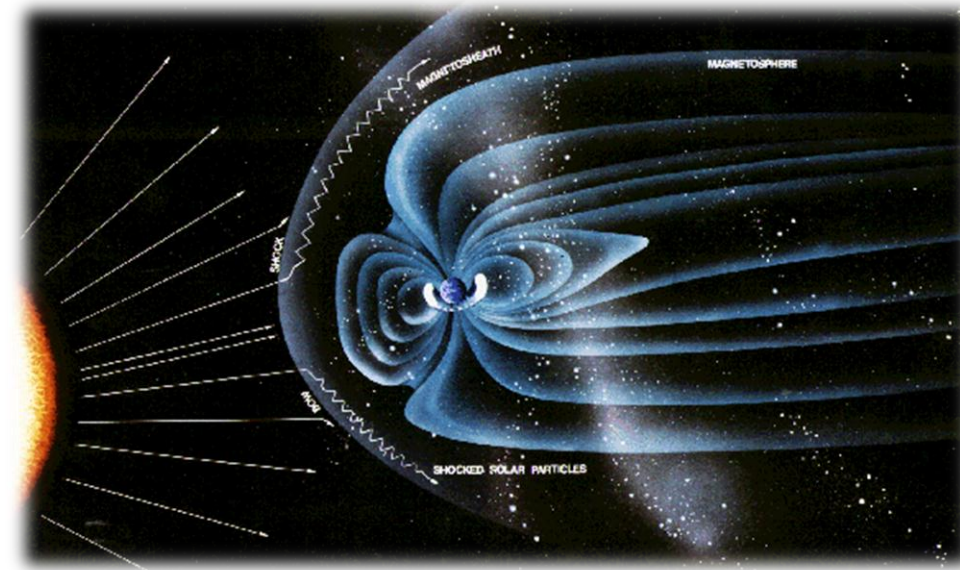

- The deviation from the power law, observed below 10 GeV, is a consequence of the influence of the solar wind called solar modulation.
- Flux intensity in this energy range is anti-correlated to the solar activity and follows the sun-spot 11-year cycle
- The correlation between the solar activity and the modulation of the cosmic rays flux has been studied by monitoring the flux of atmospheric neutrons.
- A flux of low energy neutrons ($E \sim 10^8$ - 10^9 eV) is produced in the interaction of primary CRs with the atmosphere and it is mostly due to low energy primaries (1-20 GeV), due to the rapid fall of the primary flux intensity with energy.
- One assumes that far from the solar system there exists an unmodified flux called Local Interstellar Spectrum, which is modified within the solar system by the interaction with the solar wind. This interaction is well described by the Fokker-Planck diffusion equation, that can be obtained describing the solar wind by a set of magnetic irregularities, and considering these irregularities as perfect elastic scattering centers
- For energies above 100 MeV this equation can be solved using the "Force Field Approximation"

Solar modulation (2)

- According to the **Force Field Approximation**, at a given distance from the Sun, for example at 1 a.u., the population of CRs at energy $E_{\text{interstellar}}$ is shifted at the energy E_0 as in an energy loss mechanism due to a potential V :

$$E_0 = E_{\text{interstellar}} + Z \times V_{\text{solarwind}}(t)$$

- The solar wind potential at a given distance from the Sun depends on only one parameter, the time: $V = V(t)$. So it doesn't matter what the interstellar flux is: given a flux on the Earth at a time t , one can find the flux at another time just from the relative variation of the solar wind potential F .
- In FLUKA, an offline code uses an algorithm which takes into account
 - ▣ either a given F value expressing the effect of the interplanetary modulation of the local interstellar spectrum
 - ▣ or the counting rate of the **CLIMAX** neutron monitor to provide the flux prediction at a specific date

The model is not a description of the processes and of the way in which they occur, but reasonably predicts the GCR modulation at Earth.



Solar modulation (4)

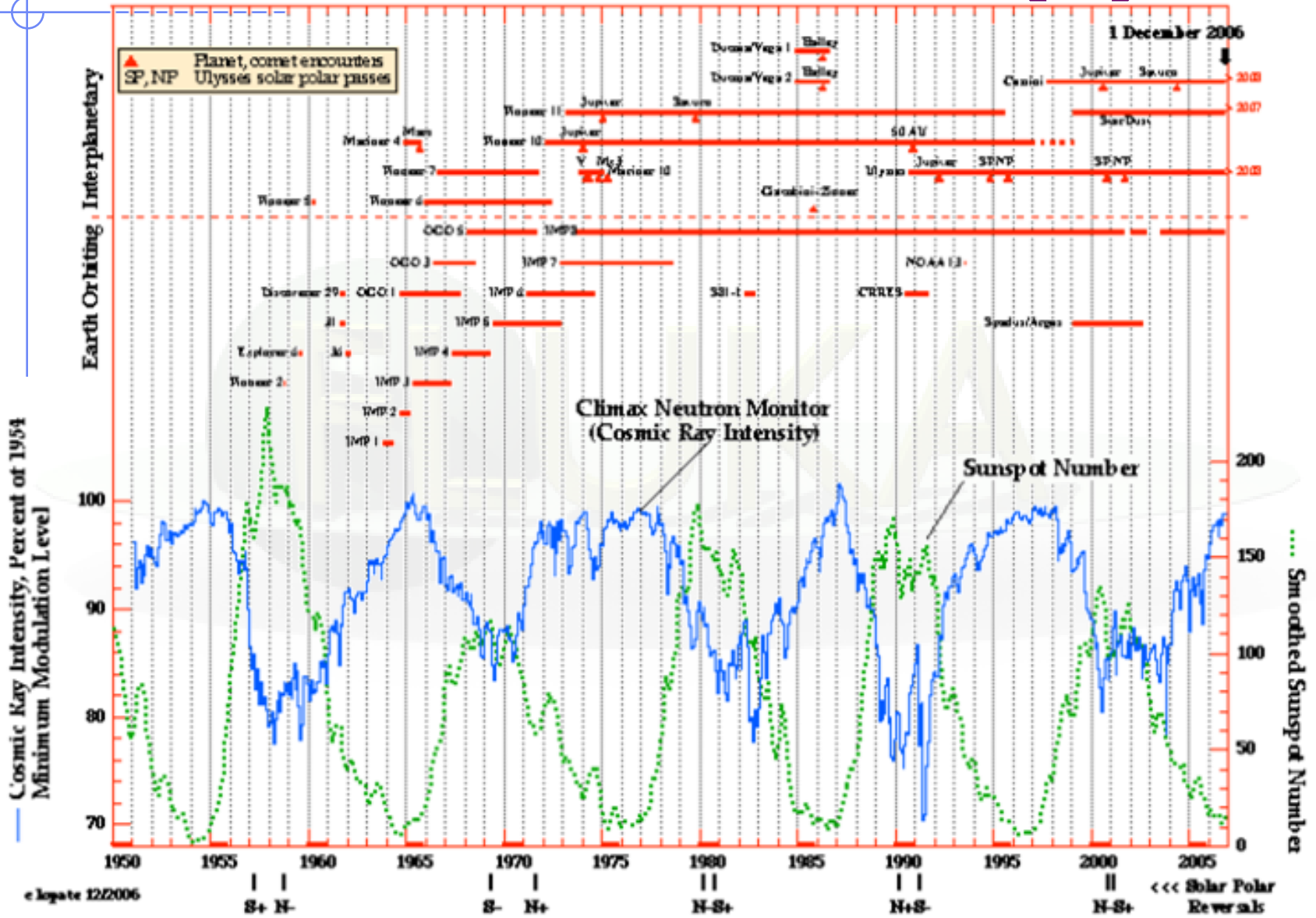

Climax Neutron Monitor

Solar Particle Events

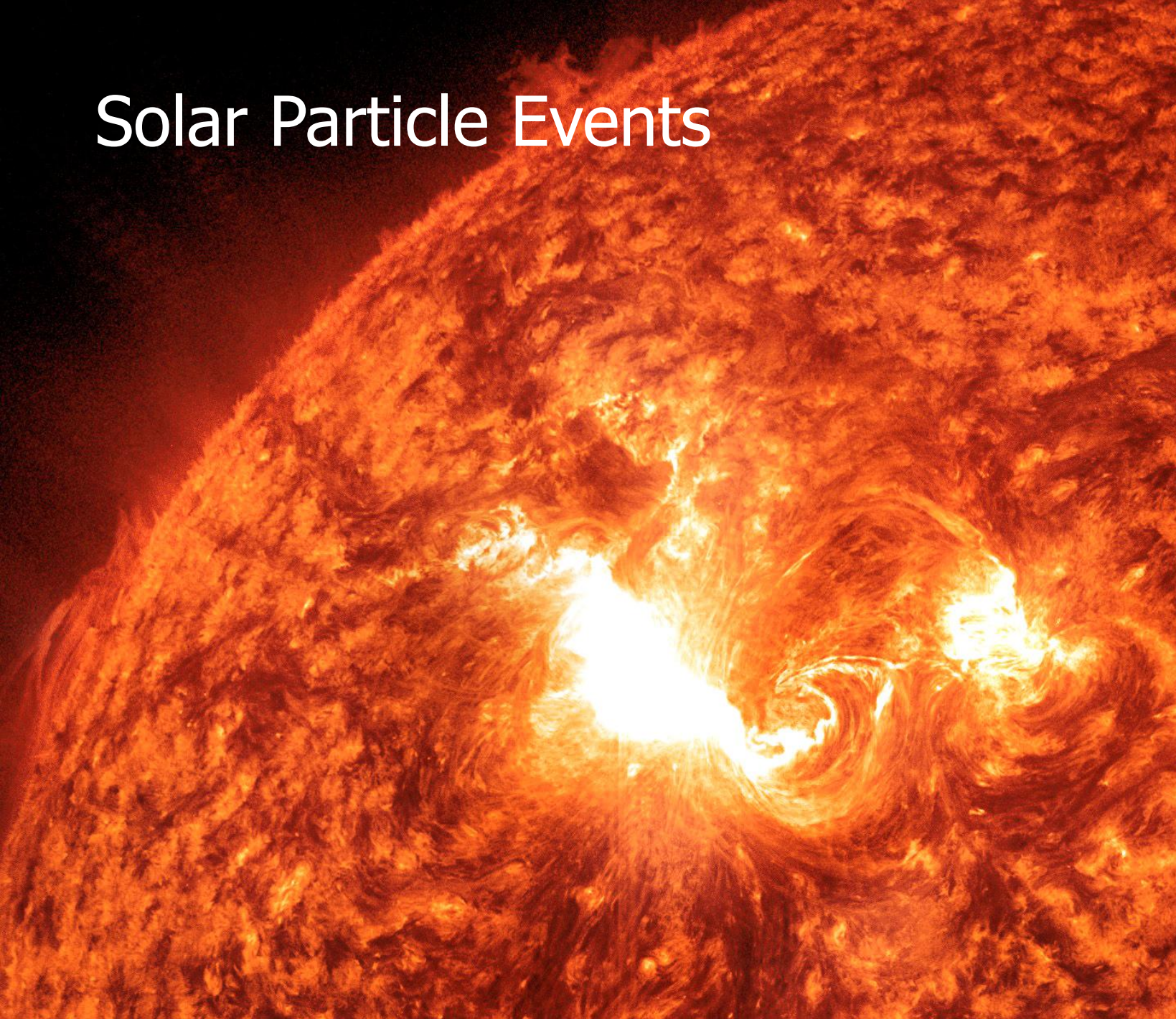

A Solar
Flare

Solar Energetic Particle (SEP) events

- Integrated fluence: up to 10^{11} (nucleons/cm²), $E > 1$ MeV / n
- Large variations in spectra
- Variable composition: mostly protons (~90%) and α 's (~9%), but ions up to Iron are not negligible
- Variable duration, from hours to days
- Rise time from minutes to hours
- Dose equivalent up to ~Sv, highly dependent on organ, shielding, and SEP intensity/spectrum
- Unpredictable



Nightmare scenarios for (manned) missions beyond Earth low orbits

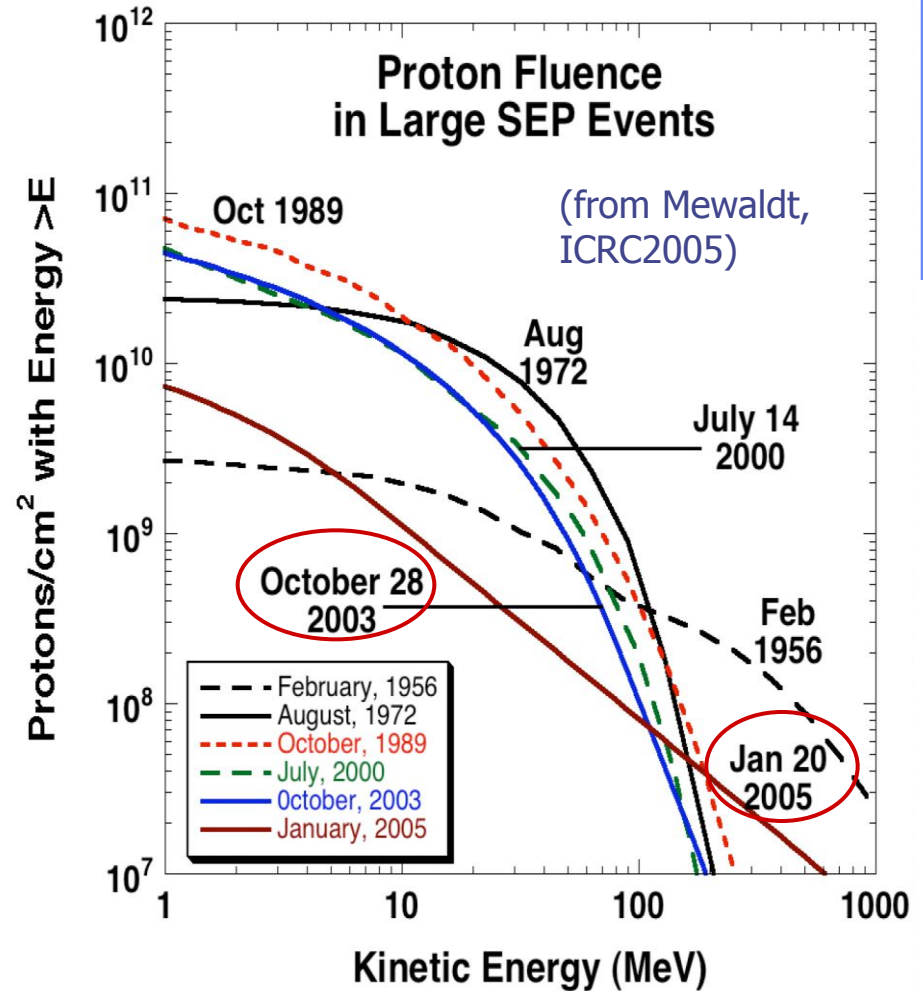

SEP: the "hard" event of 20 Jan 2005

- Integrated flux: $\sim 7 \cdot 10^9$ (nucleon/cm²),
E > 1 MeV / n
- The hardest spectrum after the "famous"
February 1956 event
- Detectable increase in ground level
muons above 5 GeV !!!
- Very fast rise time (\sim minutes)

Solar Particle Events: lower energies
but much higher intensities than
Galactic Cosmic Rays

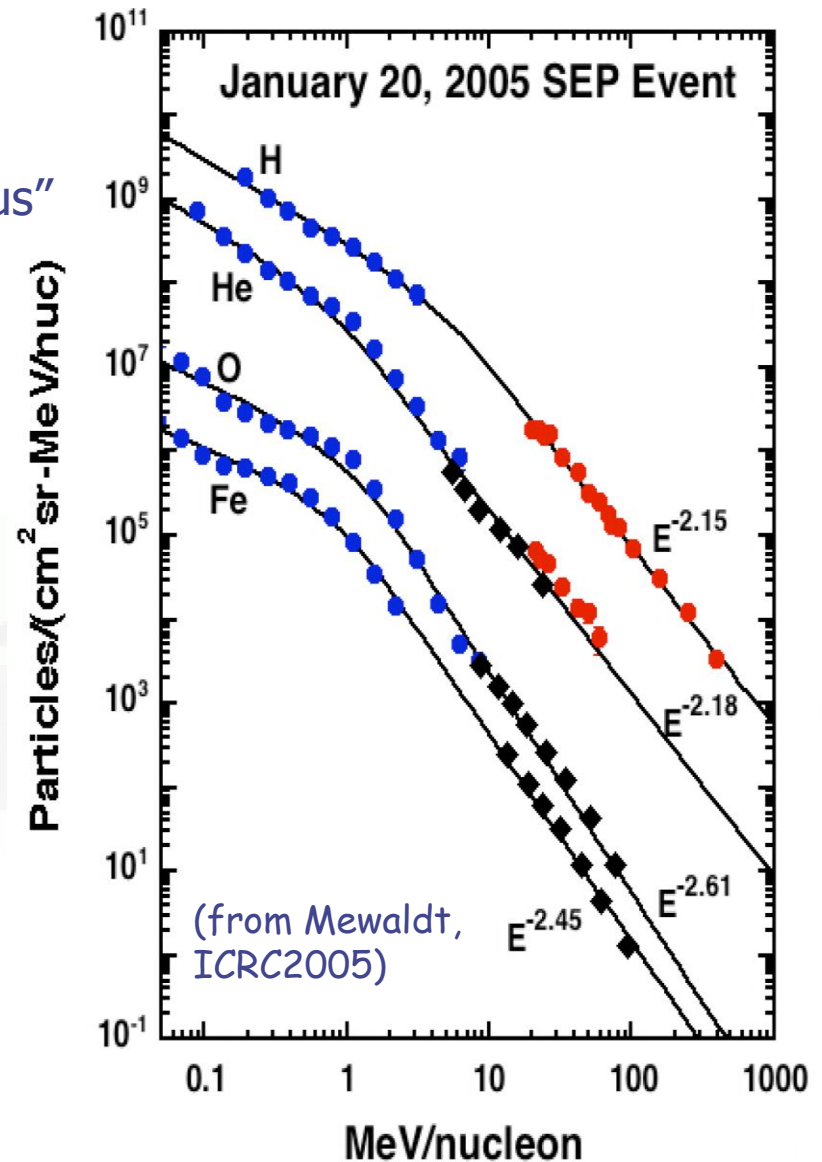

Atmospheric model: geometry (1)

The Earth atmosphere model

- The FLUKA package makes use of a density vs. height profile of atmosphere
- An external program containing a functional fit to this profile is used to generate at the same time an input geometry file, together with the data cards for material description (each atmospheric layer, having its proper density, needs to be assigned a different FLUKA material)
- The geometry produced, and distributed with the name **atmogeocards** is a spherical representation of the whole Earth atmosphere.
- The material definitions and assignment contained in the file **atmomat.cards** correspond to the density profile of the U.S. Standard atmosphere. The cards contained in atmomat.cards shall be included by the user in the input file.

Atmospheric model: geometry (2)

The Earth atmosphere model

- In addition, the user can specialize this geometry to a given geomagnetic latitude and longitude with the help of the `atmloc_2011.f` auxiliary program. In this way, the geometry will contain only a slice of the atmosphere, centered on the given position
- The local geometry file produced by `atmloc_2011.f` is named `atmloc.geo`. The user shall rename this geometry file for further use. More auxiliary files are produced by `atmloc_2011.f`:
 - ❑ the file `atmlocmat.cards` contain additional material assignments to be included in the input together with the ones from `atmogeo.cards`
 - ❑ the file `atmloc.sur` contains data used by FLUKA runtime, and normalization areas

Atmospheric model: geometry (3)

Local atmosphere model

- The geometry is built using two truncated cones (TRC) whose vertex is in the center of the Earth, the base out of the atmosphere and the height (considering a geographical location in the northern hemisphere) is in the direction of the Earth radius which passes through the North Pole

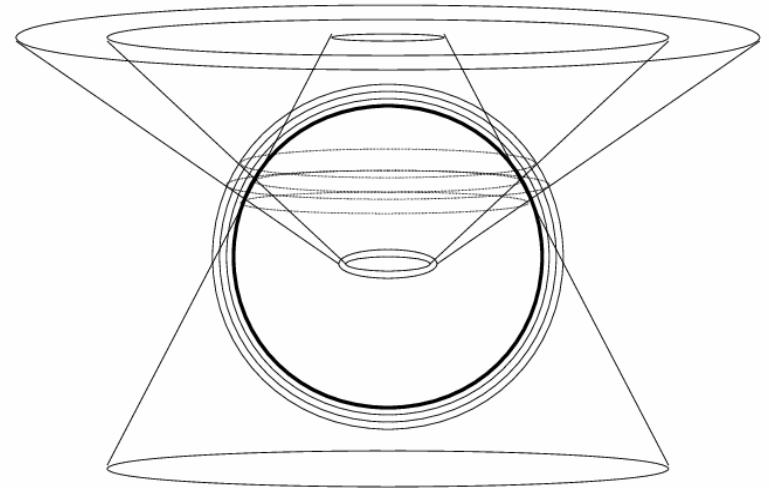

The angular span between the two cones contains the atmosphere of interest for the latitude of interest. In addition there is a third cone placed in the opposite direction: its vertex is where the other two cones have the base, its base is out of the atmosphere and its height is in the direction of the Earth radius which passes through the South Pole

A similar geometry can be built for a requested latitude in the southern hemisphere.

Atmospheric model: geometry (4)

Local atmosphere model

The user builds the complete geometry of the local model, specialized to a given geomagnetic latitude and longitude, with the auxiliary program `atmloc_2011.f`.

The geometry (file `atmloc.geo`), containing only one slice of the atmosphere centered on the given position, will be made of:

- a main series of layers made from the part of the atmospheric shells **between the two cones** (this is the part where the scoring takes place)
- two series of side layers made from the part of the atmospheric shells **between one of the two cones and the third one**

These additional layers are needed to take into account the primary and secondary particles which don't come from the vertical direction but can anyway reach the region of interest.

A file `atmlocmat.cards` will contain additional material assignments to be included in the input.

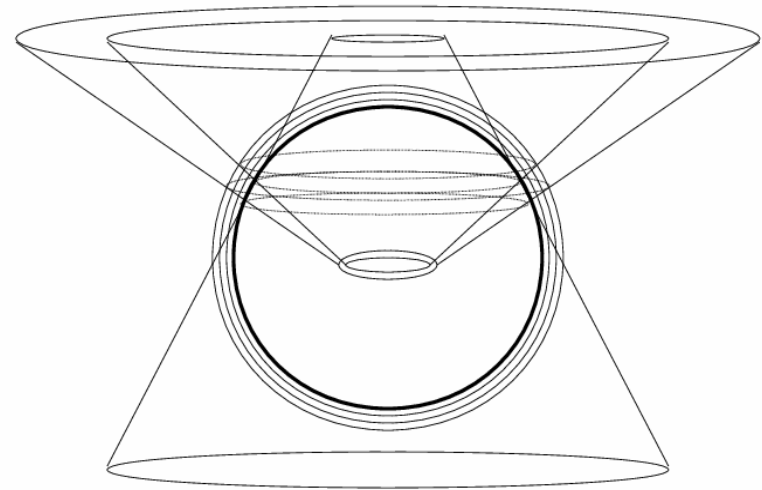

Atmospheric model: density (1)

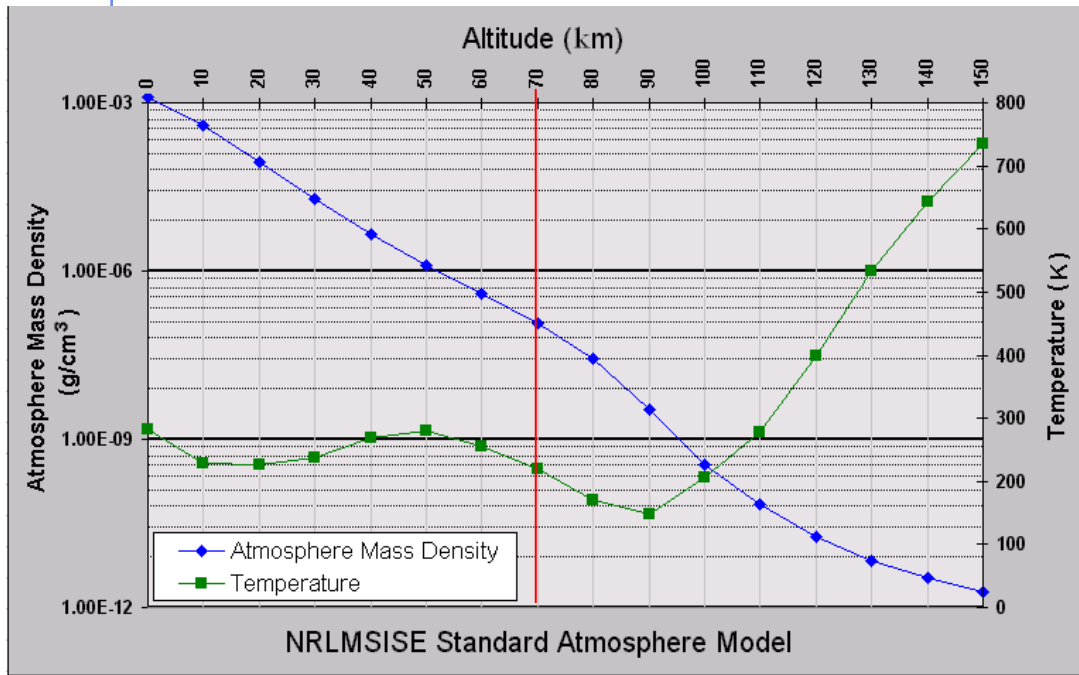

The atmosphere can be roughly characterized as the region from sea level to about 1000 km altitude around the globe, where neutral gases can be detected.

Below 50 km the atmosphere can be assumed to be homogeneously mixed and can be treated as a perfect gas. Above 80 km the hydrostatic equilibrium gradually breaks down as diffusion and vertical transport become important. The FLUKA atmospheric model, below 70 km, is in the perfect gas region.

Atmospheric model: density (2)

This Table shows the U.S. Standard Atmosphere depth vs altitude and vs FLUKA atmospheric layer.

100 layers from 0 to 70 km above sea level.

They will be described as 100 different FLUKA regions, corresponding to 100 different materials (air, with different densities)

| FLUKA region | km from s.l. | US St. Atm. Depth (g/cm ²) | FLUKA region | km from s.l. | US St. Atm. Depth (g/cm ²) | FLUKA region | km from s.l. | US St. Atm. Depth (g/cm ²) |
|--------------|--------------|--|--------------|--------------|--|--------------|--------------|--|
| 1.0 | 70.0 | 0.092 | 35.0 | 31.6 | 9.367 | 69.0 | 10.7 | 242.777 |
| 2.0 | 68.5 | 0.108 | 36.0 | 30.8 | 10.540 | 70.0 | 10.2 | 260.107 |
| 3.0 | 67.1 | 0.126 | 37.0 | 30.0 | 11.849 | 71.0 | 9.8 | 278.093 |
| 4.0 | 65.6 | 0.146 | 38.0 | 29.2 | 13.309 | 72.0 | 9.4 | 296.729 |
| 5.0 | 64.2 | 0.170 | 39.0 | 28.4 | 14.937 | 73.0 | 8.9 | 316.007 |
| 6.0 | 62.8 | 0.198 | 40.0 | 27.7 | 16.748 | 74.0 | 8.5 | 335.921 |
| 7.0 | 61.5 | 0.230 | 41.0 | 26.9 | 18.763 | 75.0 | 8.1 | 356.460 |
| 8.0 | 60.1 | 0.266 | 42.0 | 26.2 | 21.004 | 76.0 | 7.7 | 377.615 |
| 9.0 | 58.8 | 0.308 | 43.0 | 25.5 | 23.492 | 77.0 | 7.3 | 399.374 |
| 10.0 | 57.5 | 0.356 | 44.0 | 24.8 | 26.255 | 78.0 | 6.9 | 421.727 |
| 11.0 | 56.2 | 0.411 | 45.0 | 24.1 | 29.290 | 79.0 | 6.6 | 444.661 |
| 12.0 | 55.0 | 0.474 | 46.0 | 23.4 | 32.613 | 80.0 | 6.2 | 468.163 |
| 13.0 | 53.8 | 0.546 | 47.0 | 22.7 | 36.244 | 81.0 | 5.8 | 492.219 |
| 14.0 | 52.5 | 0.628 | 48.0 | 22.1 | 40.205 | 82.0 | 5.5 | 516.815 |
| 15.0 | 51.4 | 0.722 | 49.0 | 21.4 | 44.516 | 83.0 | 5.1 | 541.936 |
| 16.0 | 50.2 | 0.828 | 50.0 | 20.8 | 49.201 | 84.0 | 4.8 | 567.566 |
| 17.0 | 49.1 | 0.950 | 51.0 | 20.2 | 54.283 | 85.0 | 4.4 | 593.691 |
| 18.0 | 47.9 | 1.088 | 52.0 | 19.6 | 59.785 | 86.0 | 4.1 | 620.295 |
| 19.0 | 46.8 | 1.245 | 53.0 | 19.0 | 65.733 | 87.0 | 3.8 | 647.359 |
| 20.0 | 45.7 | 1.423 | 54.0 | 18.4 | 72.152 | 88.0 | 3.4 | 674.869 |
| 21.0 | 44.7 | 1.625 | 55.0 | 17.8 | 79.068 | 89.0 | 3.1 | 702.807 |
| 22.0 | 43.6 | 1.854 | 56.0 | 17.2 | 86.506 | 90.0 | 2.8 | 731.155 |
| 23.0 | 42.6 | 2.112 | 57.0 | 16.7 | 94.493 | 91.0 | 2.5 | 759.898 |
| 24.0 | 41.6 | 2.404 | 58.0 | 16.1 | 103.057 | 92.0 | 2.2 | 789.016 |
| 25.0 | 40.6 | 2.734 | 59.0 | 15.6 | 112.224 | 93.0 | 1.9 | 818.493 |
| 26.0 | 39.6 | 3.106 | 60.0 | 15.0 | 122.023 | 94.0 | 1.6 | 848.311 |
| 27.0 | 38.7 | 3.525 | 61.0 | 14.5 | 132.482 | 95.0 | 1.3 | 878.453 |
| 28.0 | 37.7 | 3.996 | 62.0 | 14.0 | 143.628 | 96.0 | 1.1 | 908.900 |
| 29.0 | 36.8 | 4.526 | 63.0 | 13.5 | 155.489 | 97.0 | 0.8 | 939.636 |
| 30.0 | 35.9 | 5.121 | 64.0 | 13.0 | 168.094 | 98.0 | 0.5 | 970.643 |
| 31.0 | 35.0 | 5.789 | 65.0 | 12.5 | 181.471 | 99.0 | 0.3 | 1001.903 |
| 32.0 | 34.1 | 6.538 | 66.0 | 12.0 | 195.646 | 100.0 | 0.0 | 1033.400 |
| 33.0 | 33.3 | 7.378 | 67.0 | 11.6 | 210.649 | | | |
| 34.0 | 32.4 | 8.317 | 68.0 | 11.1 | 226.507 | | | |

Geomagnetic field (1)



In the last 50 years measurements of the geomagnetic field configuration have been performed regularly with increasing precision, revealing a yearly weakening of the field intensity of 0.07% and a westward drift of ~ 0.2 degrees per year over the Earth's surface.

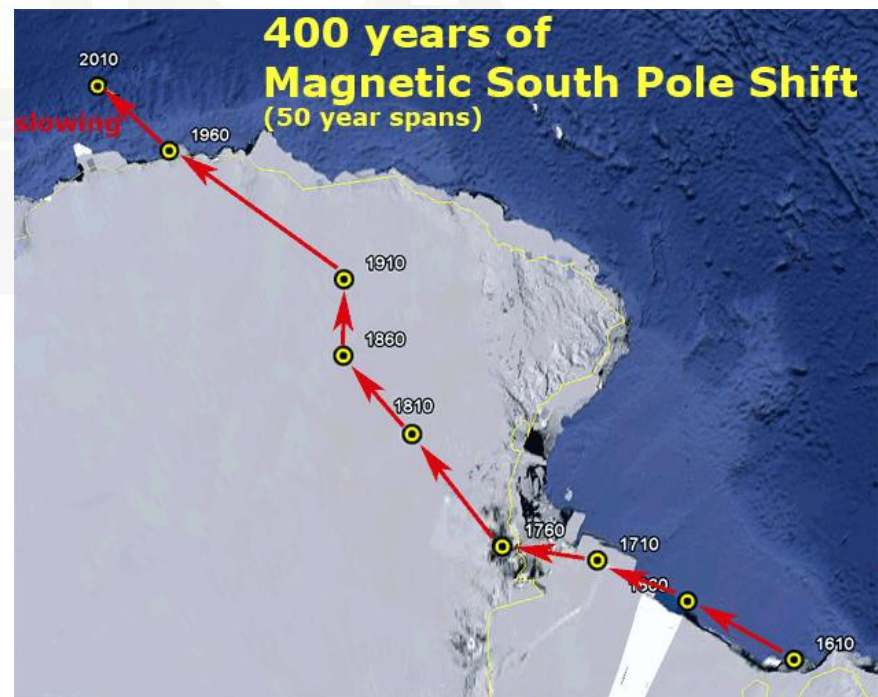

Geomagnetic field (2)

This field can be described, to first order, as a **magnetic dipole** tilted with respect to the rotation axis by ~ 11.5 degrees, displaced by ~ 400 km with respect to the Earth's center and with a magnetic moment $M = 8.1 \times 10^{25}$ G cm³ (8.1×10^{22} A m²). The dipole orientation is such that the magnetic South pole is located near the geographic North pole, in Greenland, at a latitude of 75° N and a longitude of 291° .

The Earth's Magnetic Field

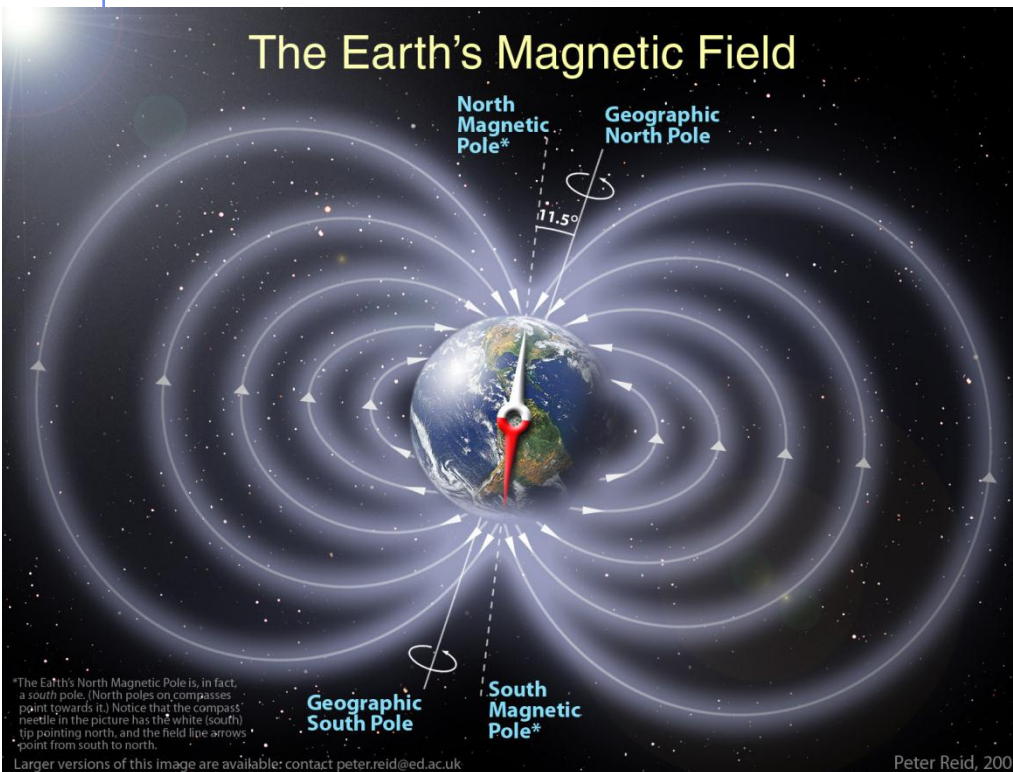

Geomagnetic field (3)

The magnetic North pole is instead near the geographic South pole, on the border of the Antarctica.

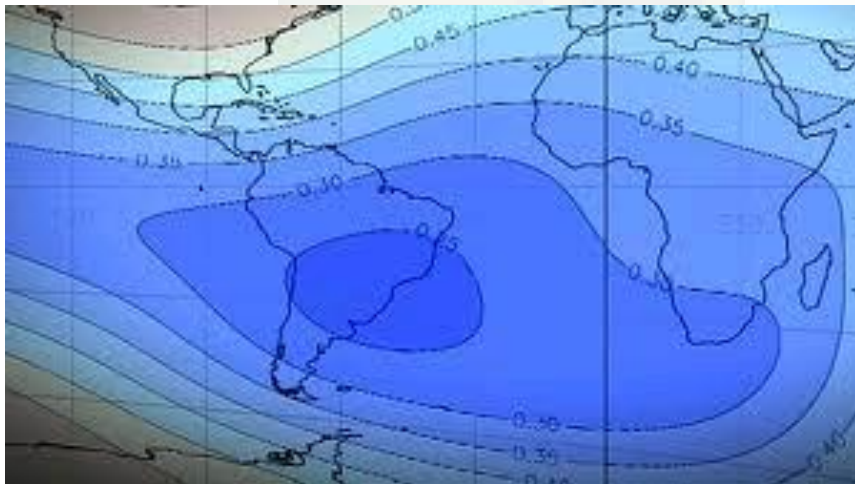

The intensity at the Earth's surface varies from a maximum of $\sim 6 \times 10^{-5}$ T near the magnetic poles to a minimum of $\sim 2 \times 10^{-5}$ T in the region of the South Atlantic Anomaly (SAA), between Brazil and South Africa. The complex behavior of the equipotential field lines is mainly a consequence of the offset and tilt.

Geomagnetic field (4)

In FLUKA the geomagnetic field is **taken into account in two different stages:**

- 1) Effect of geomagnetic cutoff which modulates the primary spectrum:** at a given location (point of first interaction of primary particles) and for a given direction, a **threshold in magnetic rigidity** exists. The closer the injection point is to the geomagnetic equator, the higher will be the vertical rigidity threshold. The standard possibility offered to the user is to evaluate the geomagnetic cutoff making use of a dipolar field centered with respect to the centre of the Earth, adapted to give the "correct" vertical rigidity cutoff for the geographic location under examination.
- 2) The local geomagnetic field can be taken into account during shower development in the atmosphere.** The field is automatically provided by the default **MAGFLD** FLUKA user routine, in accordance to the option selected in the **GCR-SPE** card. For local problems, provided the coordinate system is consistently used (that is, geomagnetic coordinates for the dipolar field, geographic ones for the multipolar field) there is no need to provide any orientation or intensity information about the field.

Two commands for Cosmic Rays

GCR-SPE

Initializes Galactic Cosmic Ray or Solar Particle Event calculations

SPECSOUR

defines one of the following special sources:

- Galactic Cosmic Rays
(SDUM = GCR-IONF, GCR-SPEC, GCR-ALLF)
- Solar Particle Event
(SDUM = SPE-SPEC, SPE-2003, SPE-2005)

The usual scoring options (USRBDX, USRYIELD...) can be used to define detectors to calculate the fluence of different radiation fields.

Cosmic ray tools (1)

- A number of tools and packages have been developed for the FLUKA environment to simulate the production of secondary particles by primary cosmic rays interacting with the Earth's atmosphere. These tools, in different stand-alone versions, have already been successfully used for fundamental physics research
- The set of FLUKA tools for cosmic ray simulation includes a set of core routines to manage **event generation**, **geomagnetic effects** and **particle scoring**, a **standalone program**, and a number of **stand-alone data files**

The standalone program

- **atmloc_2011.f**: prepares the description of the local atmosphere geometry with the atmospheric shells initialized by option **GCR-SPE**. This geometry includes only a slice of the Earth geometry, centered around the geomagnetic latitude input by the user

Cosmic ray tools (2)

The files

- **atmomat.cards**: contains the material definitions for the density profile of the US Standard Atmosphere. These cards must be inserted (or the file included with the **#include** directive) into the FLUKA input file.
- **atmogeocards**: contains an example of a 3D geometrical description of the Earth atmosphere, generated in accordance with the previous data cards (and corresponding density profile). This geometry includes the **whole Earth**
- **<iz>phi<MV>.spc**: GCR All-Particle-Spectra for the **izth** ion species (**iz** = 1,...,28), modulated for the solar activity corresponding to a **Phi** parameter **<MV>** MegaVolt. **Phi=500 MV** roughly corresponds to solar minimum, while **Phi=1400 MV** roughly corresponds to solar maximum
- **allnucok.dat**: GCR All-Nucleon Spectra
- **sep20jan2005.spc**: spectra for the Solar Particle Event of Jan 20th, 2005
- **sep28oct2003.spc**: spectra for the Solar Particle Event of Oct 28th, 2008

Summary from the manual: GCR-SPE

GCR-SPE

- **Initializes** Galactic Cosmic Ray (GCR) or Solar Particle Event (SPE) calculations
- **WHAT(1) = i0 + 1000 * i1**
 - i0 = 0:** centered dipole field, geomagnetic coordinates (used also for computing rigidity cut-off's in the spectrum generating routine)
 - = 1:** exact multipole fields, geographic coordinates
 - = 2, >3:** undefined, standard **MAGFLD** user routine called for regions with magnetic field
 - = 3:** dipolar field for infinite plane at given latitude
- i1 = number of atmospheric shells**
 - = 10000:** no atmospheric shells
 - = 101:** 100 atmospheric shells
- Default: centered dipole field, 100 shells
- **WHAT(2,3,6) =** not used
- **WHAT(4) = Earth radius** (Default provided)
- **WHAT(5) = Earth equatorial magnetic field** (Default provided)
- **SDUM =** name identifying both the spectra files (estension **.spc**) and the data file (estension **.sur**) produced by the auxiliary program **atmloc_2011.f**.

Summary from the manual: GCR-SPE, Notes

Notes to GCR-SPE :

- 1) Cosmic ray calculations, initialized by GCR-SPE are defined by means of command SPECSOUR and a number of auxiliary programs.
- 2) The cards for the geometry description of the atmospheric shells must be prepared using the auxiliary programs and data cards in the directory \$FLUPRO/gcrtools. Program atmloc_2011.f writes a file atmloc.geo, containing the geometry input to be inserted into the FLUKA input file (or to be read by setting WHAT(3) in the GEOBEGIN card), a file atmlocmat.cards containing the extra material assignments, and a file atmloc.sur containing auxiliary data and the scoring areas.

The user shall rename the file atmloc.sur to <xxxxxxx>.sur, where <xxxxxxx> is an identifier of exactly 7 characters which must appear also in the input spectra file names: the spectra must have the names <zz><xxxxxxx>.spc, where <zz> is the atomic number of the ion.

The example spectra distributed with FLUKA come with two identifiers: <zz>phi0465 for solar minimum and <zz>phi1440 for solar maximum, and with zz=01-28.

From the manual: SPECSOUR/GCR-ALLF (1)

SPECSOUR: various SDUM options are available:

- **SDUM = GCR-ALLF:** All-nucleon flux
Three different options (average, maximum and minimum flux) are available.
- The program reads fluxes from a file named **allnucok.dat** in which are given the **total energy** (GeV), the **fluxes** (E.dN/dE) and the **neutron/proton ratios**.
- It is possible to give an energy interval and to choose:
 - ❑ a starting radius (radius of the emission sphere in case of spherical geometry)
or
 - ❑ a starting height (the emission height in case of flat geometry).
- It is possible to activate the vertical geomagnetic cutoff and to give the cutoff value at the central latitude, otherwise the geomagnetic cutoff will be not taken into account.
- Ions are treated as separate nucleons, or as alphas and protons.

From the manual: SPECSOUR/GCR-ALLF (2)

SPECSOUR:

- **SDUM = GCR-ALLF:** All-nucleon flux
- **WHAT(1) = 1:** central value ; **= 2:** minimum value; **= 3:** maximum value
- **WHAT(2) >= 0:** starting radius (cm) ; **< 0:** starting height (cm)
- **WHAT(3) =** Minimum energy
- **WHAT(4) =** Maximum energy
- **WHAT(5) =** Spectral index for sampling (below transition energy)
- **WHAT(6) =** Transition energy for sampling (above it, sample from 1/E)

Continuation card (SDUM = "&"):

- **WHAT(1) = 0:** no geomagnetic cutoff
 - = 1: geomagnetic cutoff is requested
 - = 2: the vertical geomagnetic cutoff is read as WHAT(2)
- **WHAT(2) =** vertical geomag. cutoff at central latitude for WHAT(1) = 2
- **WHAT(3)-WHAT(5):** not used
- **WHAT(6) =< 0:** nucleons are transported separately
 - > 0: transport as many alphas as can be built by neutrons, and the remaining protons

From the manual: SPECSOUR/GCR-IONF (1)

- SDUM = GCR-IONF: All-particle flux

The particle composition of the flux can be modified by choosing the minimum and maximum atomic number ($1 \leq Z \leq 28$).

- The spectrum components have been produced by a code for various modulation parameters and written on '.spc' files ($Z + \langle \text{PhiMV} \rangle + .\text{spc}$).
- It is possible to give an energy interval and to choose a starting radius (radius of the emission sphere in case of spherical geometry) or starting height (the emission height in case of flat geometry).
- It is possible to activate the geomagnetic cutoff (WHAT(7) in SPECSOUR) and to input optionally the vertical cutoff value at the central latitude.
- Ions are treated like real ions or can be splitted. The optimized value for spectral index for sampling (below transition energy) is $\gamma = 1.75$ (WHAT(5)).
- Above transition energy, the spectrum will be assumed to have a $1/E$ shape.

Summary from the manual: SPECSOUR/SPE-xxxx

SDUM = SPE-SPEC, SPE-2003 or SPE-2005: Solar Particle Event.

SPE-SPEC, SPE-2005 → spectrum is read from file `sep20jan2005.spc`

SPE-2003 → spectrum is read from file `sep28oct2003.spc`

The WHATs are the same as for SDUM=GCR-IONF:

- **WHAT (1)** = $Z_{\max} + 100 * Z_{\min}$ ($Z_{\min} = 1$ if none is defined)
- **WHAT (2)** = Starting radius or starting height (cm)
- **WHAT (3)** = Minimum energy
- **WHAT (4)** = Maximum energy

If max. and minimum energy differ by $< 5\%$ then a fixed energy (= Max) is sampled

- **WHAT (5)** = Spectral index for sampling (below transition energy)
- **WHAT (6)** = Transition energy for sampling (above it, sample from $1/E$)

Continuation card (**SDUM = "&"**)

- **WHAT(1)** = 0: no geomagnetic cutoff; = 1: geomagnetic cutoff is requested
= 2: the vertical geomagnetic cutoff is read from WHAT(2)
- **WHAT(2)** = vertical geomagnetic cutoff at central latitude for WHAT(1) = 2
- **WHAT(3)** = number of energy point in the spectra. Default: 50
- **WHAT(4)** = if > 0 vertical run
- **WHAT(5)** = if > 0 probabilities $1/(2xZ)$ are used for the various ions (1 for $Z = 1$)
- **WHAT(6)** = < 0 : ions are split > 0 : ions are treated like real ions

Example of input data cards

- An example of user data cards to run a FLUKA cosmic ray problem. is shown here. The example refers to the simulation at geographical coordinates of 36.0 degrees North Latitude and 140.0 degrees East Longitude (Tsukuba, Japan), using the solar modulation of Dec. 23rd 1995: μ^+ and μ^- fluxes at different heights in the atmosphere.

Example available in `$FLUPRO/gcrtools/gcrexamples/AllParticleExample`

SPECSOUR and **SDUM = GCR-IONF** (all particle flux):

Z of ions of spectra to be taken into account

- information for sampling energy spectra
- geomagnetic cutoff
- starting radius

GCR-SPE: Initializes Galactic Cosmic Ray or Solar Particle Event calculations :

- geomagnetic field
- spectra files name

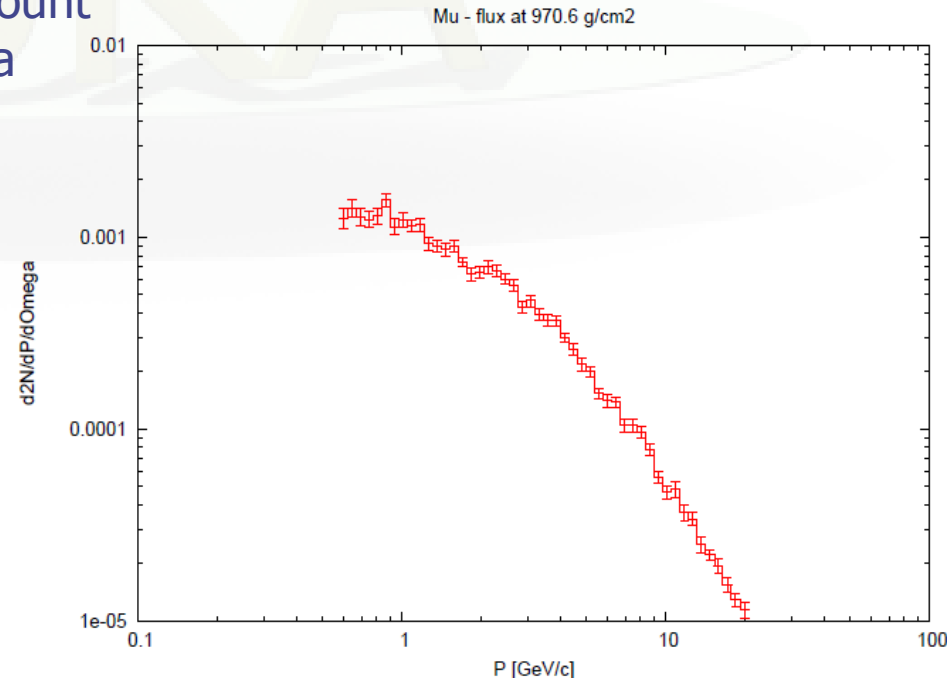

GCR-SPE

initializes Galactic Cosmic Ray or Solar Particle Event calculations

```
100 atm shells, dipole field, read spectra from zzphi0465.spc
GCR-SPE                               Field: naive dipole ▼
Equatorial Field:                      Dump shell: 0
Shells: 101                            Unit: 0
Radius:
DateFile: phi0465
```

- What(1): various options for the magnetic field
- What(4): Earth radius
- What(5): Equatorial magnetic field
- SDUM: name of spectra files

SPECSOUR with SDUM GCR-SPE calls special GCR source

(SPECSOUR doesn't only define GCR spectra - read 16.7)

```
** No Dpmjet:
  Z range Inj.Radius Emin   Emax   Sampling parameters
  flag   vert. cutoff          split
SPECSOUR                               Type: GCR-IONF ▼
#1 28.0                               #2 6.449E+08
#5 1.75                               #6 500.0
#9                                     #10
#13||                                #14
#17                                  #18
#30.3
#7 2.0
#11
#12 1.0
#16
```

First card:

(1) Z range, (2) Inj.Radius, (3) Emin, (4) Emax, (5) Sampling index, (6) Transition energy

Second card:

(7) cutoff?, (8) cutoff, (9)(# energy points), (10)(vertical run), (11)(ion probabilities), (12) split

Muon benchmark: CAPRICE

Momentum bin (GeV/c)

Open symbols: CAPRICE data
Full symbols: FLUKA

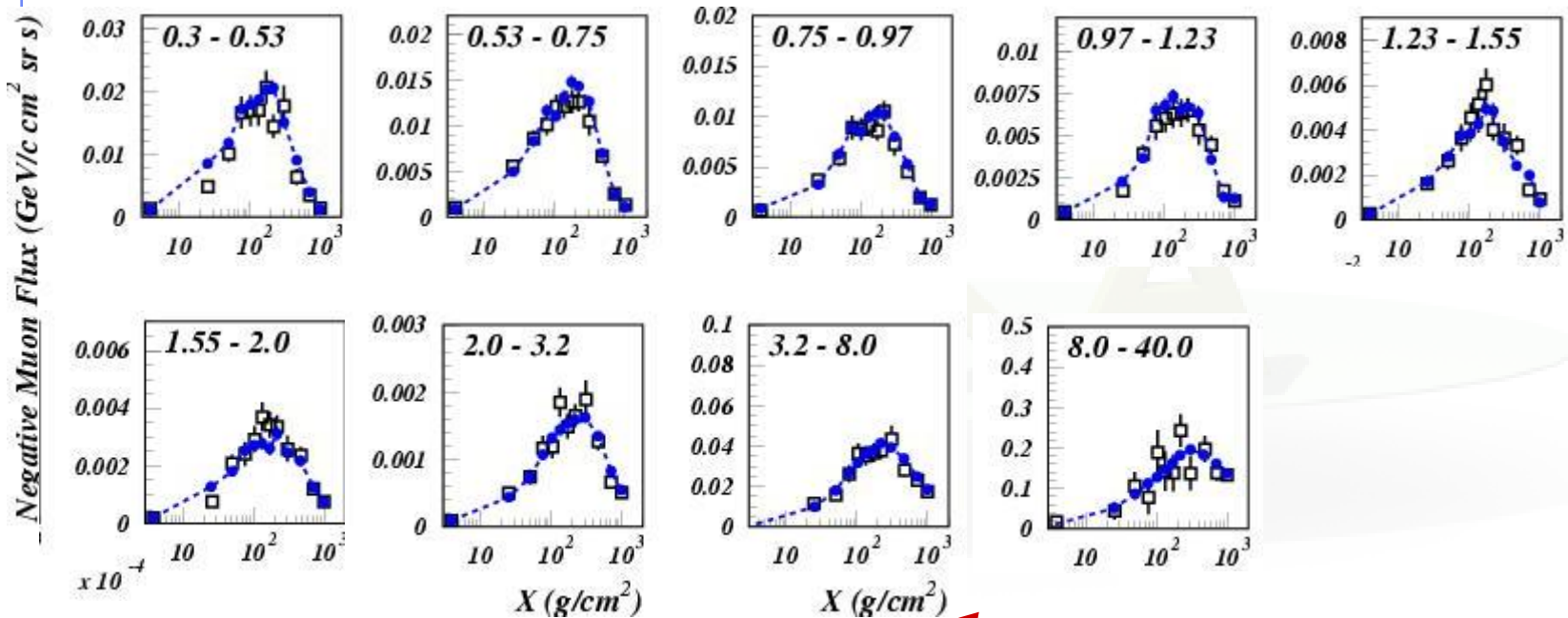

Primary spectrum normalization \sim AMS-BESS
Astrop. Phys., Vol. 17, No. 4 (2002) p. 477

Atmospheric
thickness (g/cm^2)

BESS spectrometer

Balloon-borne Experiment with Superconducting Spectrometer

The BESS spectrometer has collected data at different cut-offs, altitudes, solar modulation

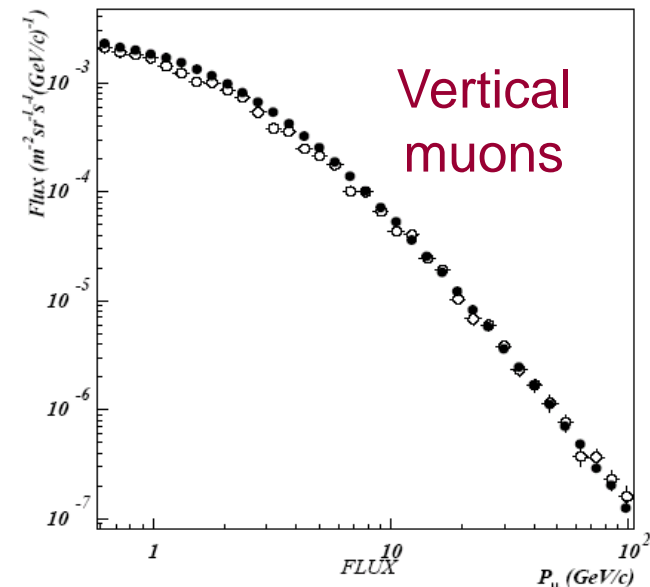
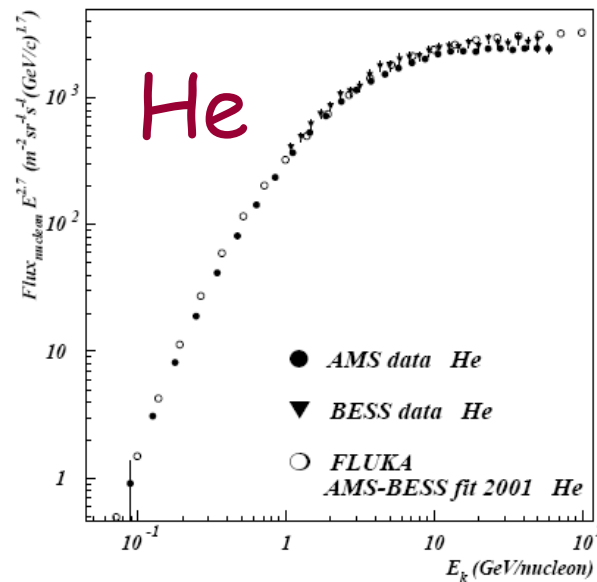
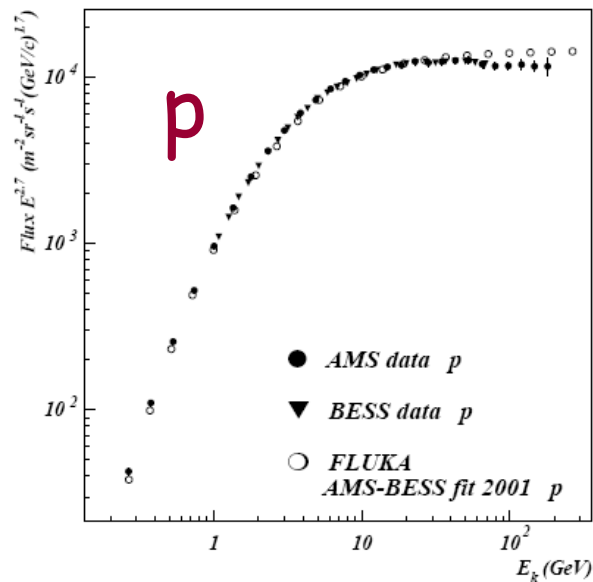
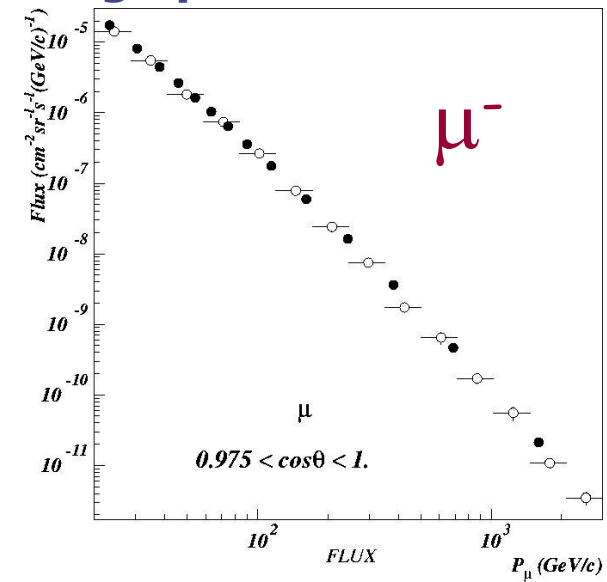

Benchmark Earth Surface

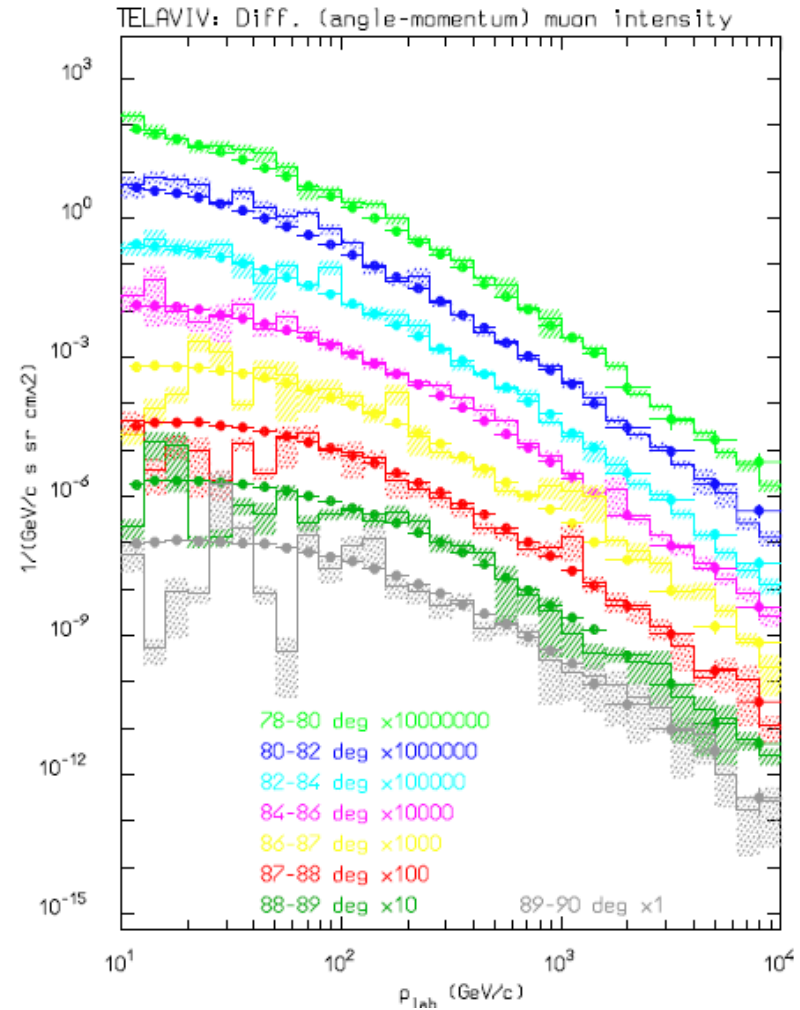
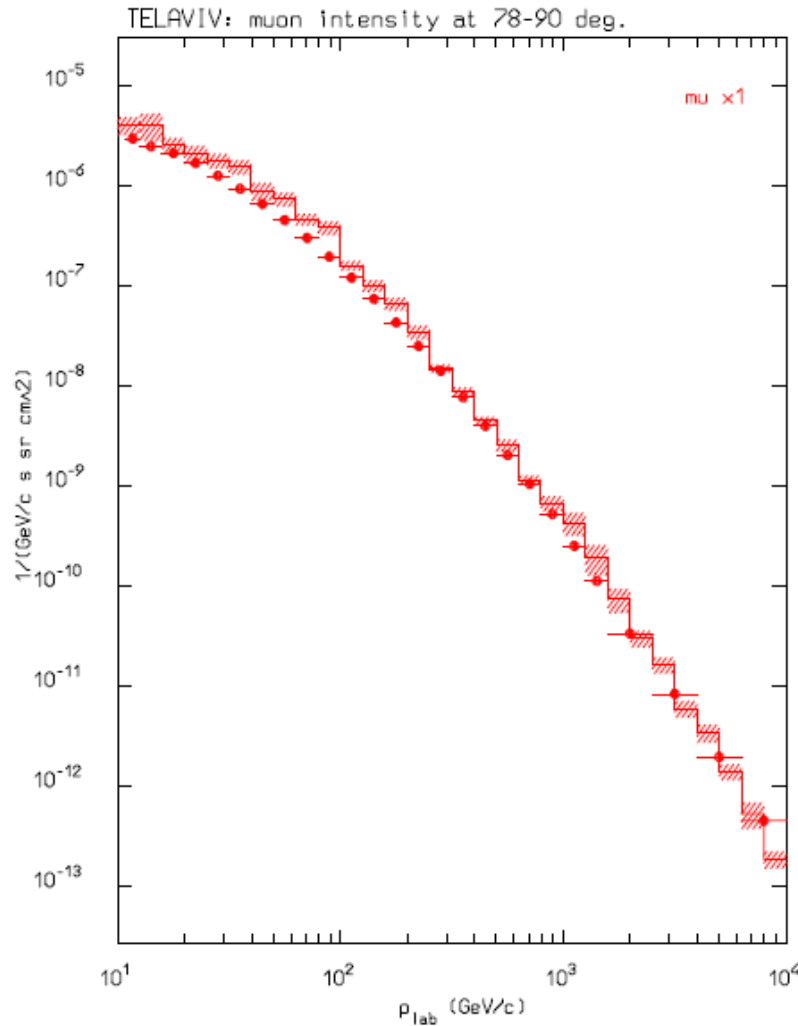

Angle integrated (78-90deg, left) and double differential muon fluxes, measured close to the horizontal line TelAviv. Data from O.C. Allkofer et al. NPB 259,1, (1985).

Neutrons on the ER-2 plane at 21 km

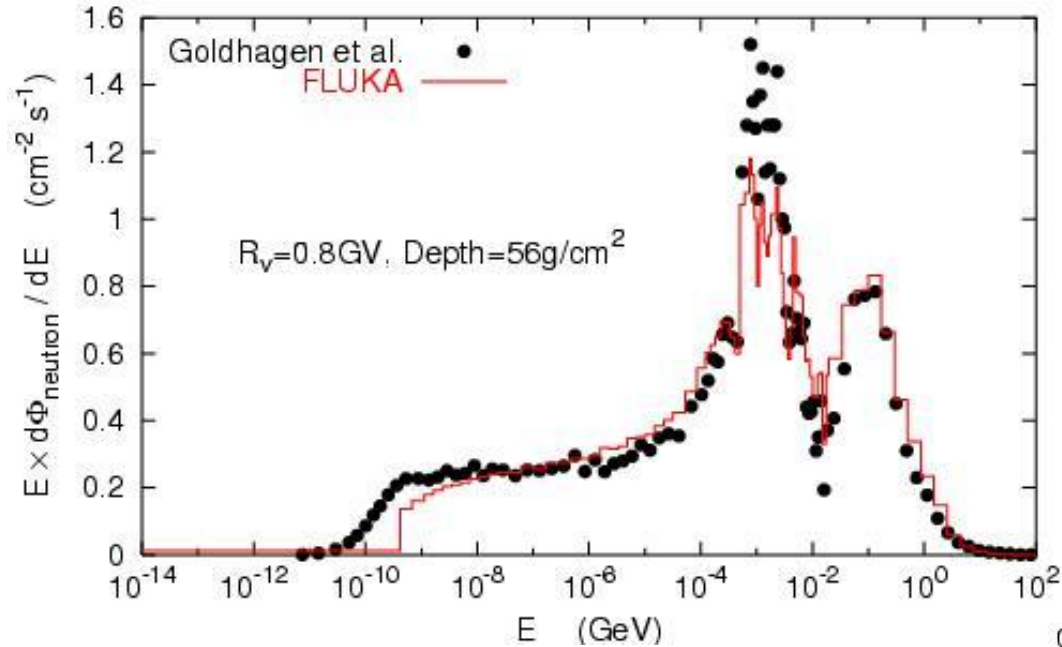

Measurements:

Goldhagen et al.,
NIM A476, 42 (2002)

Note one order of magnitude
difference depending on
latitude

FLUKA calculations:

Roesler et al.,
Rad. Prot. Dosim. 98, 367 (2002)

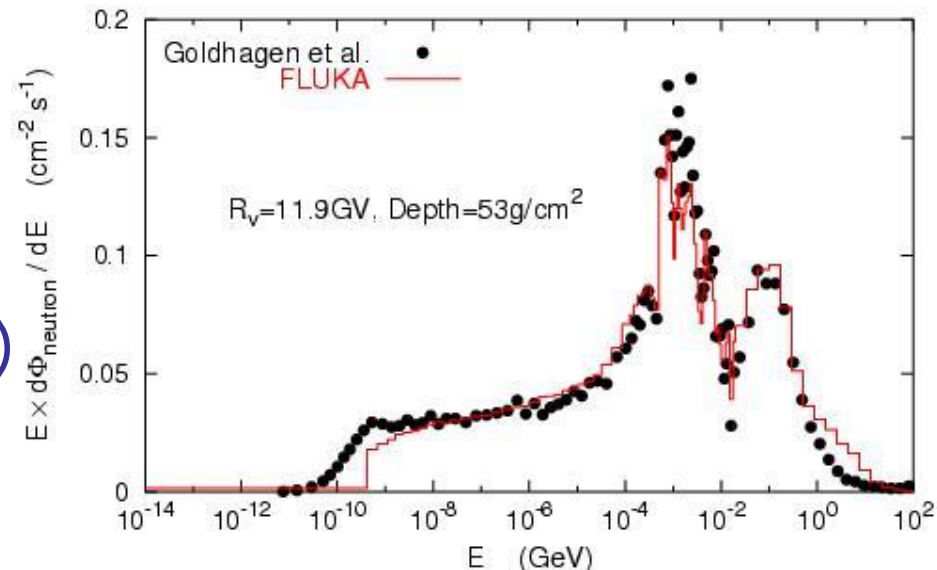

Doses to aircrew and passengers

AIRBUS 340

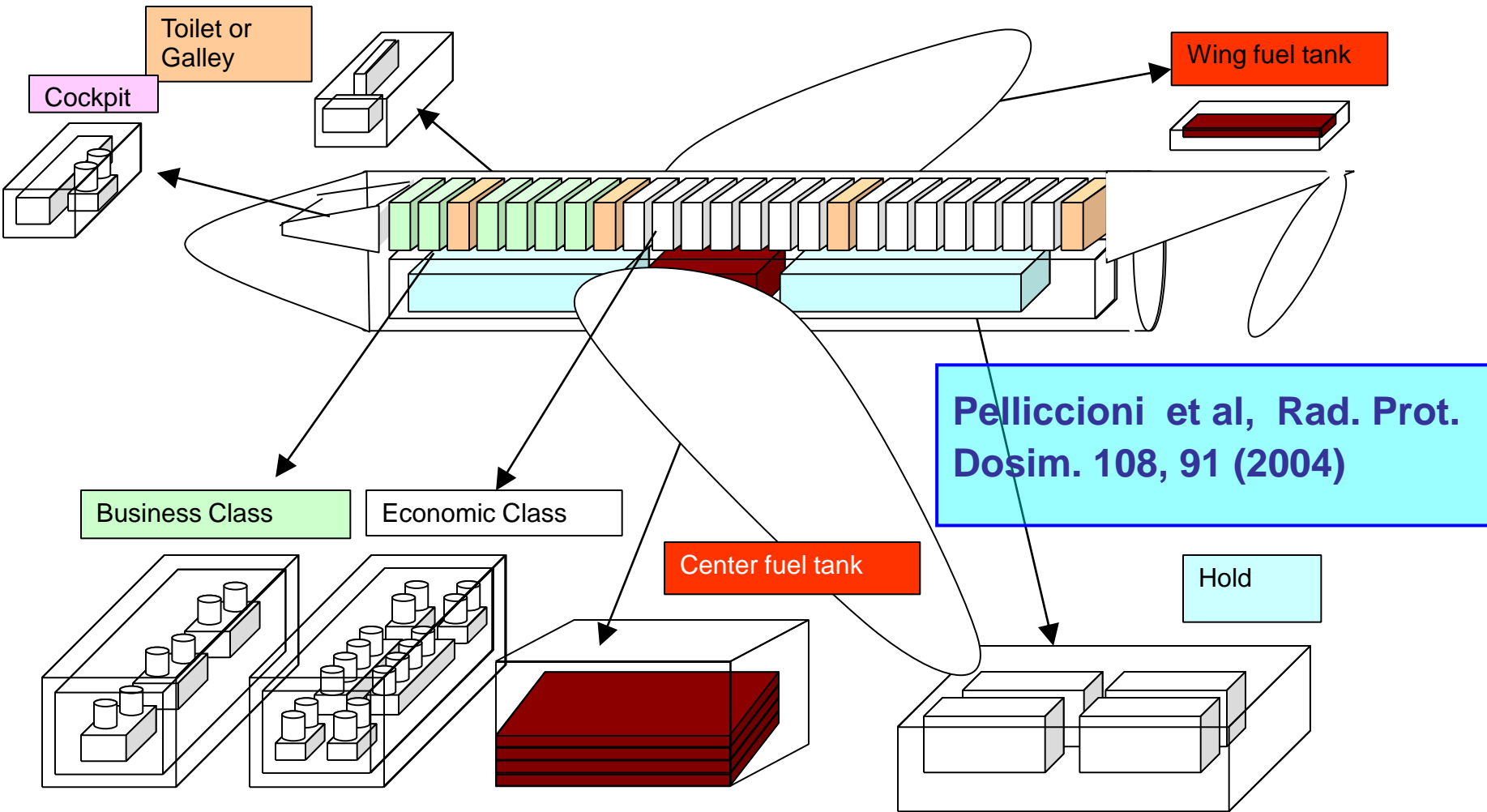

Doses to aircrew and passengers

Commercial flight doses: (Pelliccioni et al. RPD93, 101 (2001))

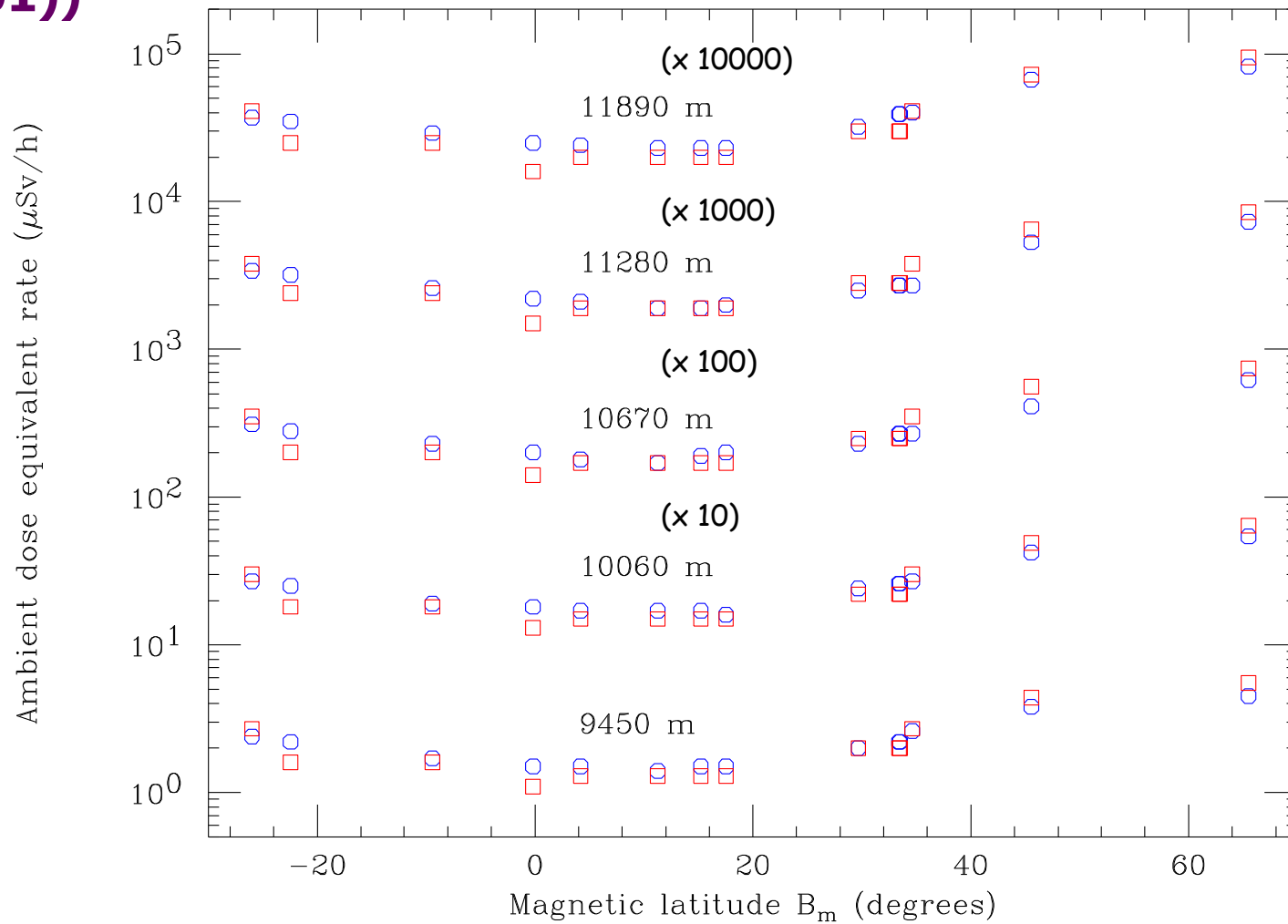

Simulated (FLUKA, red) and measured (blue, NIMA422, 621, 1999) ambient dose equivalent for various altitudes (scaled by one decade) and geomagnetic cut-off's

Doses to aircrew and passengers

Stiller et al., Rad. Prot. Dosim. 98, 367 (2002)

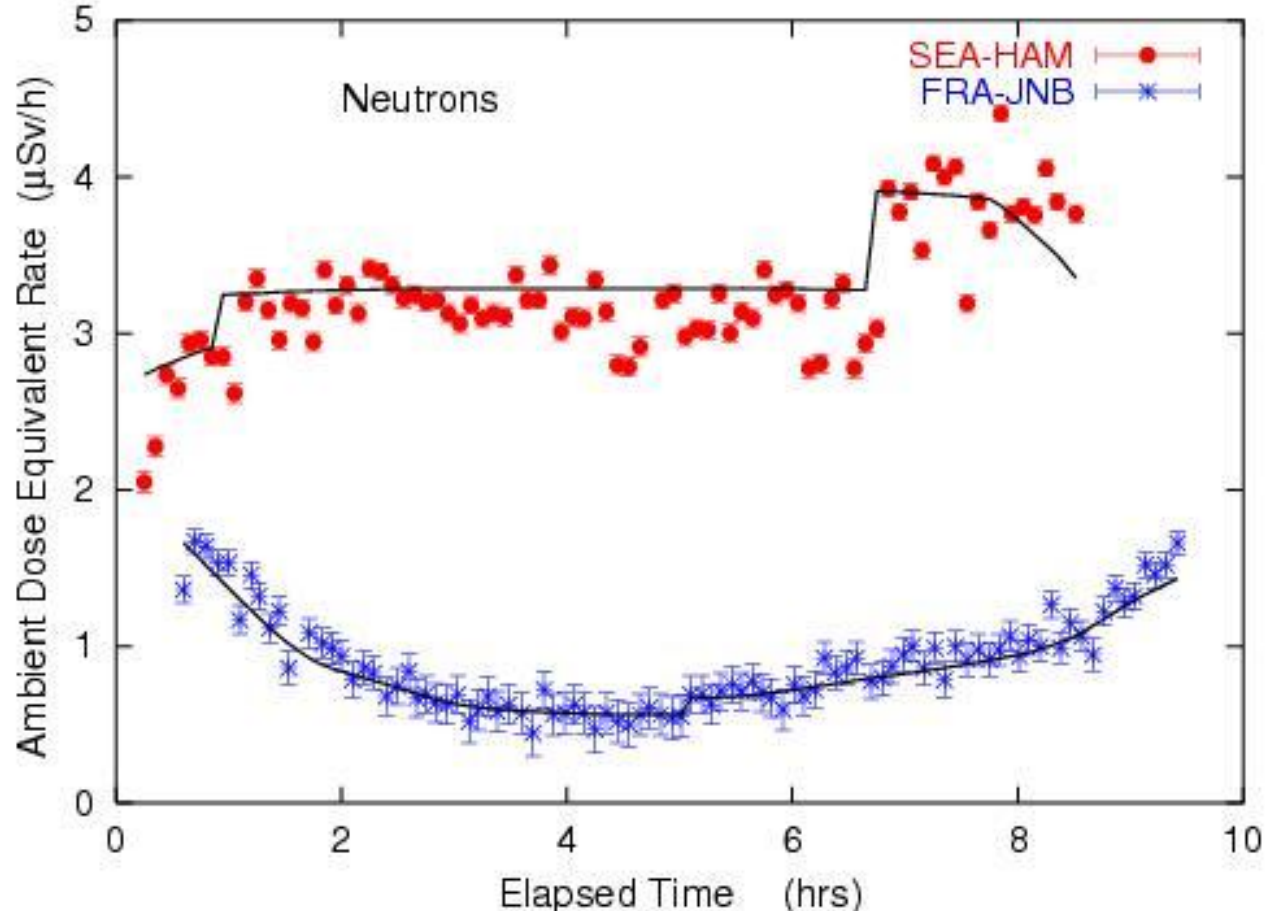

Ambient dose equivalent from neutrons at solar maximum on commercial flights from Seattle to Hamburg and from Frankfurt to Johannesburg.

Solid lines: FLUKA simulation

High-Altitude n-Spectra

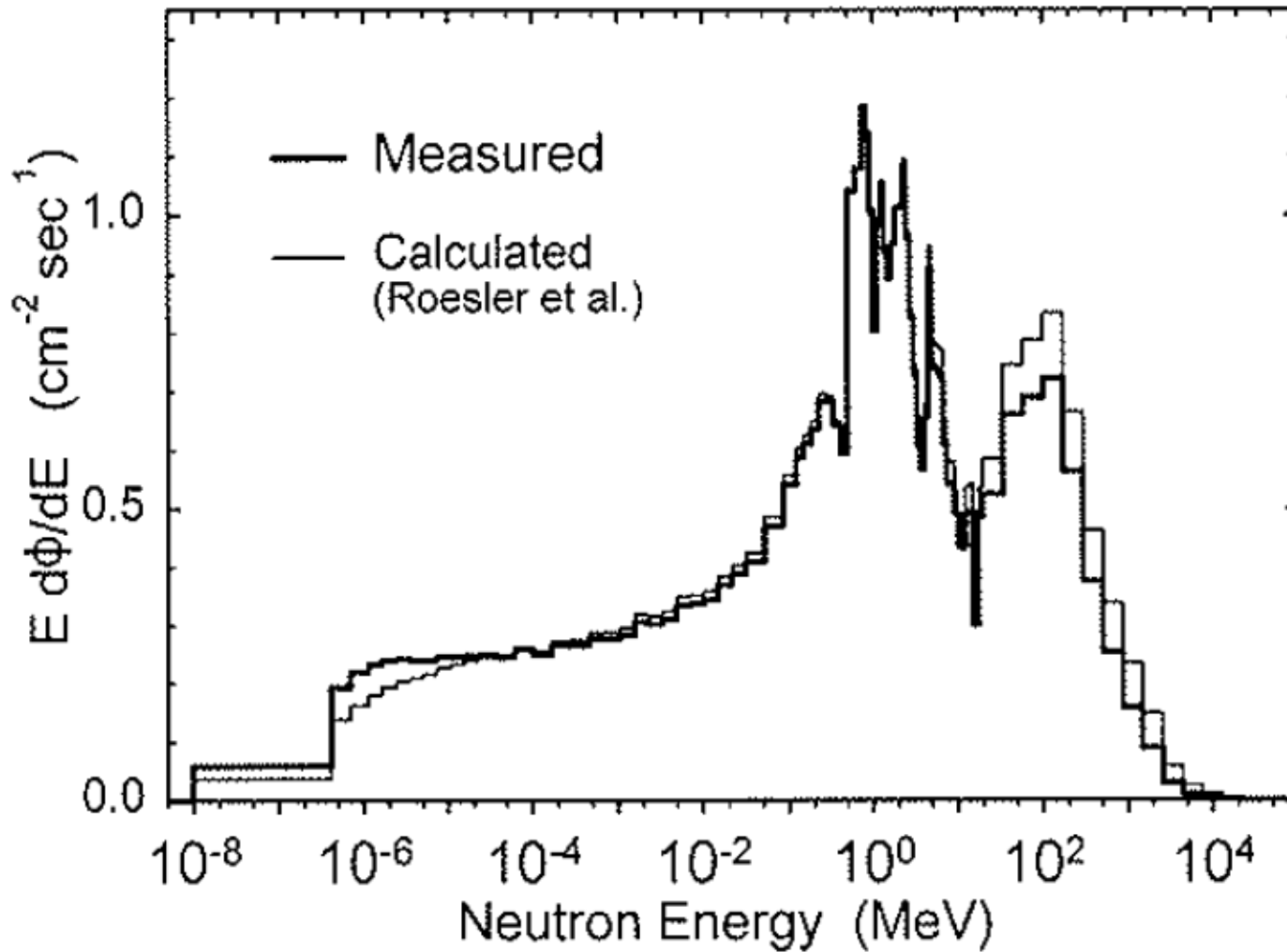

Goldhagen et al., COSPAR Proceedings, 2002